



SunGiga

1MW/2.15MWh 锂电储能系统项目——刚果(金)马科罗微电网

Storage System

DC-coupled Energy

DG

1MWp
ESS

1MW/2.15MWh

JinKO ESS

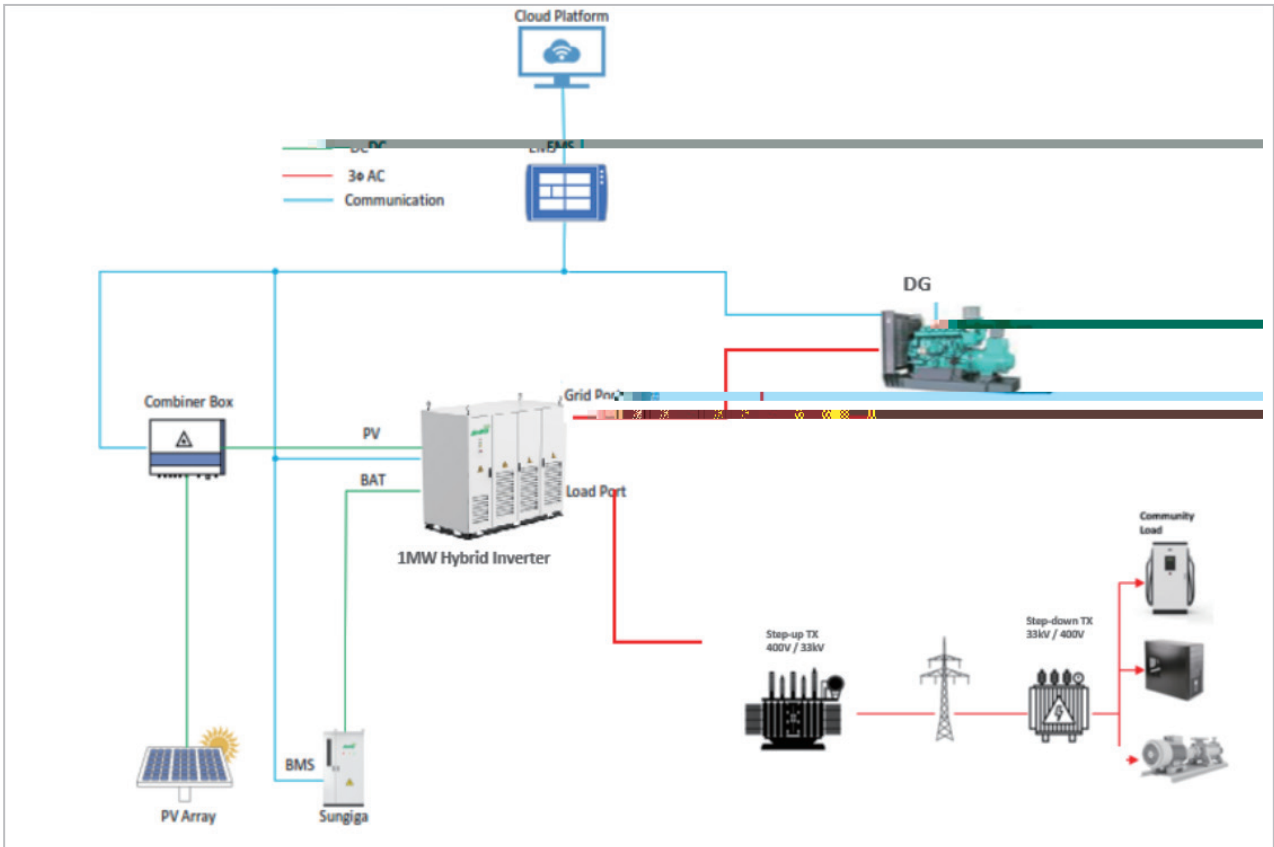

1.

BMS

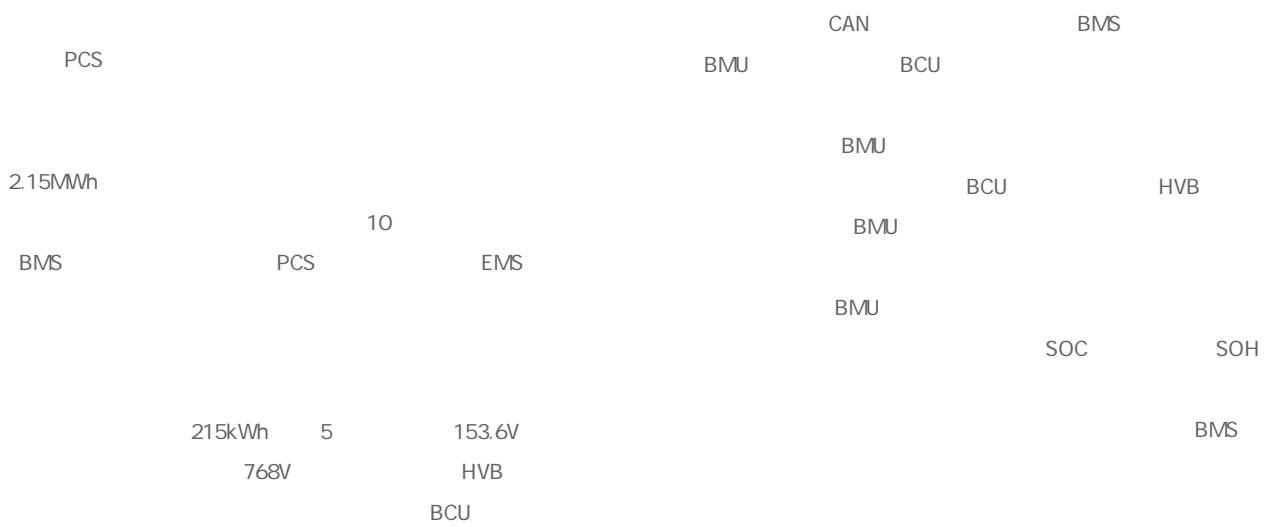

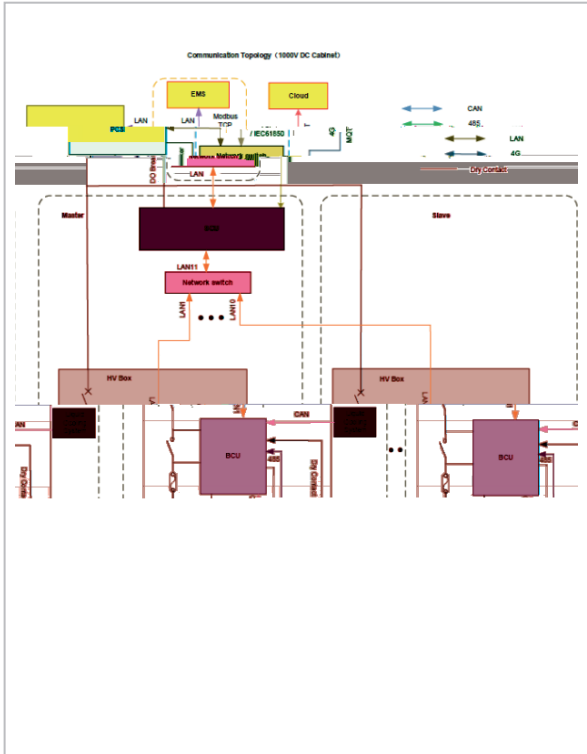

2 BMS

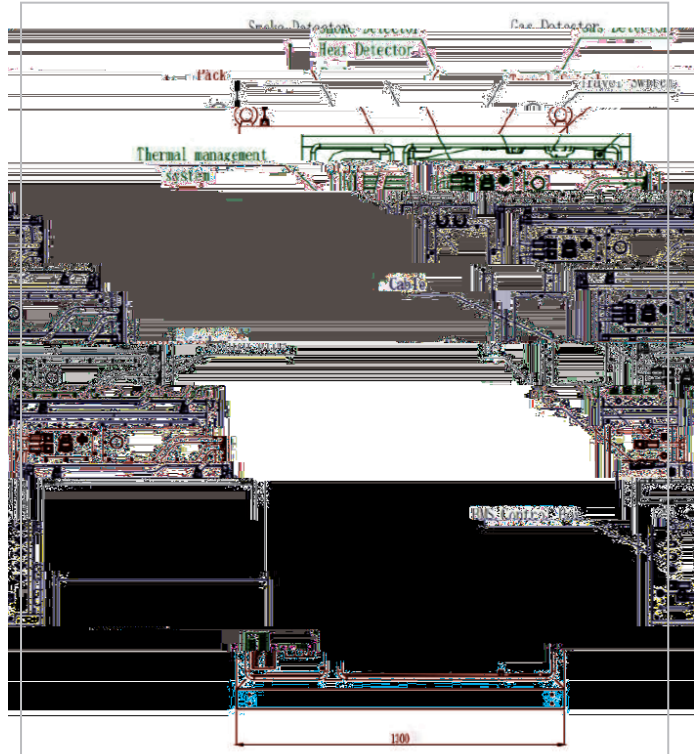

3 SunGiga

PCS

500kW 1MW PCS
 PCS PCS
 20

FSS

ESS FSS
 FSS

PCS - DC-AC
 DC-BUS - DC-DC
 DC-DC / DC-AC

DC-AC
 DC-AC
 PCS 110%

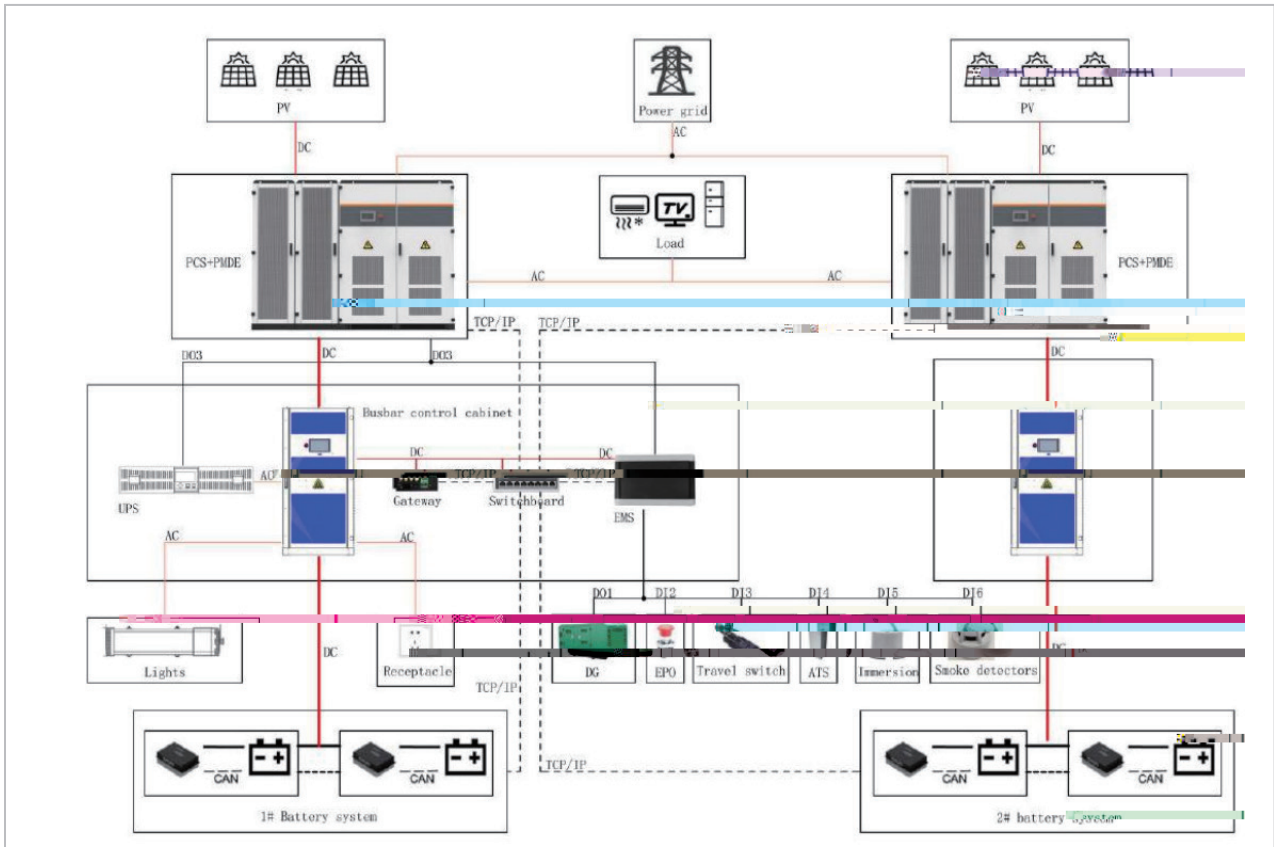

4. PCS

EMS

EMS
 EMS
 EMS
 SOC
 SOH
 EMS

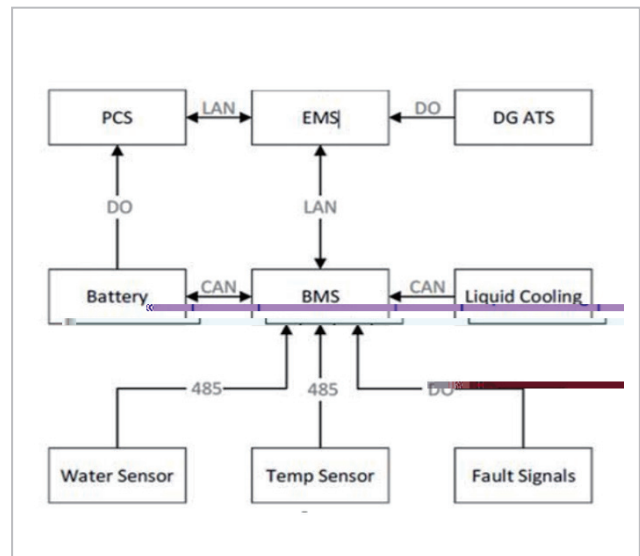

5. EMS

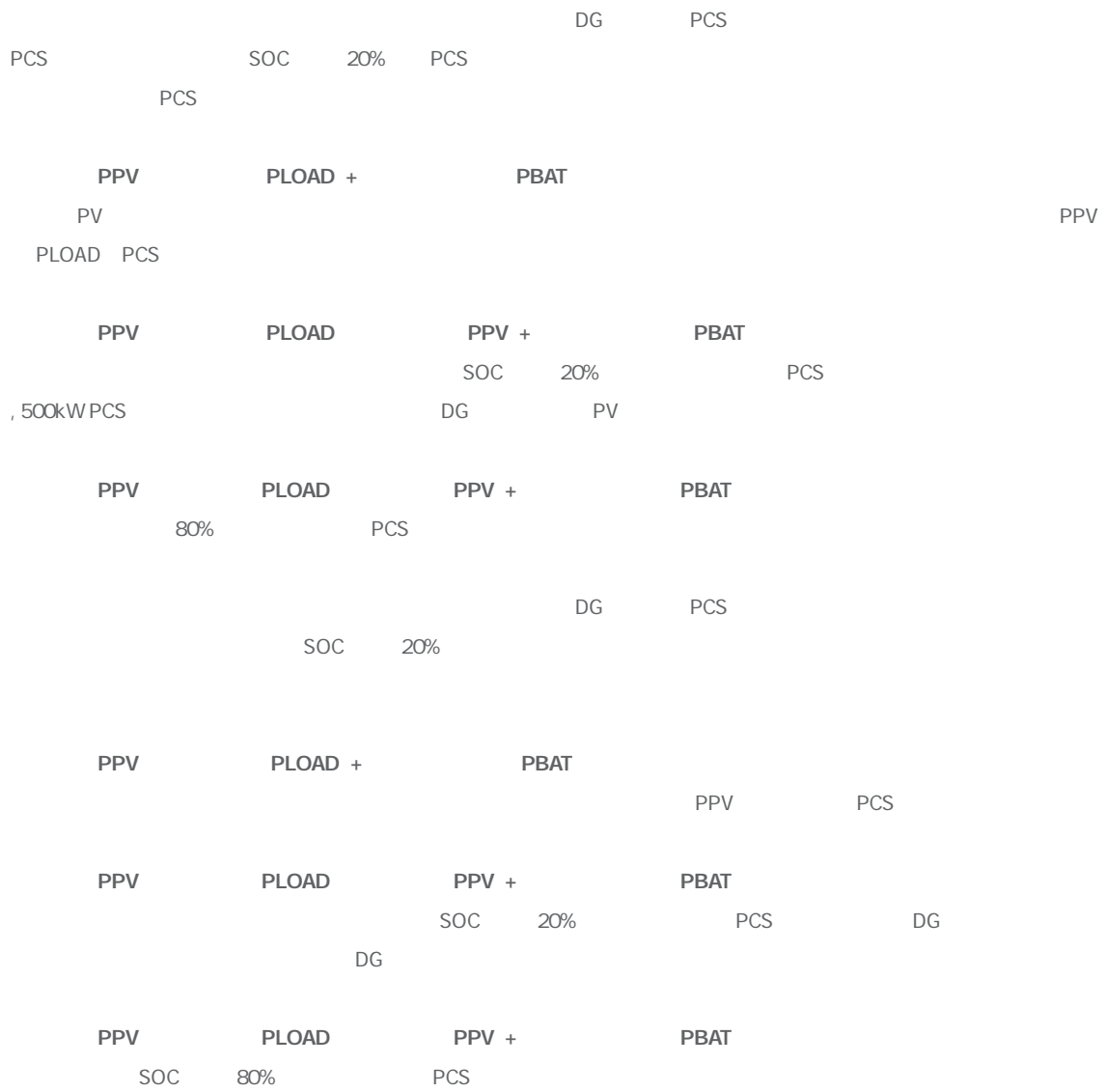

BESS



SCU

FSS	BMU	Site Control Unit, SCU	5	SunGiga
SCU	BCU		VPN	

EMS

o ,0



7.

*



+86 400 860 8878